

SolarVu® for KACO blueplanet XP10U Inverters Installation Guide

Site Preparation

SolarVu® is an energy portal that enables remote monitoring of renewable energy generation sites over the web. It requires the installation of a K135 gateway which continuously transfers data from the inverter(s). This guide explains how to connect the K135 gateway to KACO Blueplanet XP10U inverters using the RS485 serial interface.

Each inverter has RS485 communication installed as a standard feature. This guide does not cover connection to the inverter ethernet port. To access SolarVu from a browser, the inverters are connected to the internet through a Cachelan K135 gateway as shown in fig 1. The K135 connects to multiple inverters using twisted pair wire, typically cat5e, daisy chained to multiple inverters. An RJ45 ethernet jack, connected to the LAN network and 120VAC outlet for the gateway power dongle are required. The LAN must have high speed internet service to an ISP to provide a gateway to the internet as shown in figure 1.

K135 Installation

Wall mount the SolarVu® enclosure with conduit to the inverters for serial connection, LAN ethernet and 120VAC control power.

Control Power: A source of 120VAC @ 3W control power is required for the K135 gateway.

Ethernet: Use a standard ethernet patch cable with RJ45 connectors of the appropriate length to connect from the K135 to the network ethernet at a RJ45 wall jack or the router/switch.

RS485 Serial: Use twisted pair wire or two pairs in a cat5e #24AWG solid twisted pair wire cable cutting off the unused additional wires. Daisy chain from the K135 gateway to the RS485 A B in and out terminals to each inverter as shown in fig 2 using the version that matches the inverter. Connect the 485 common to a local ground at the inverter. See the Kaco XP10U manual for how to program from the front panel keys and display the unique slave address in each inverter slave typically 1,2,3 etc with the slave IDs noted on the SolarVu configuration sheet. Baud rate settings are fixed at 9600. A terminating resistor is usually not required.

Fig 1 Internet Connection

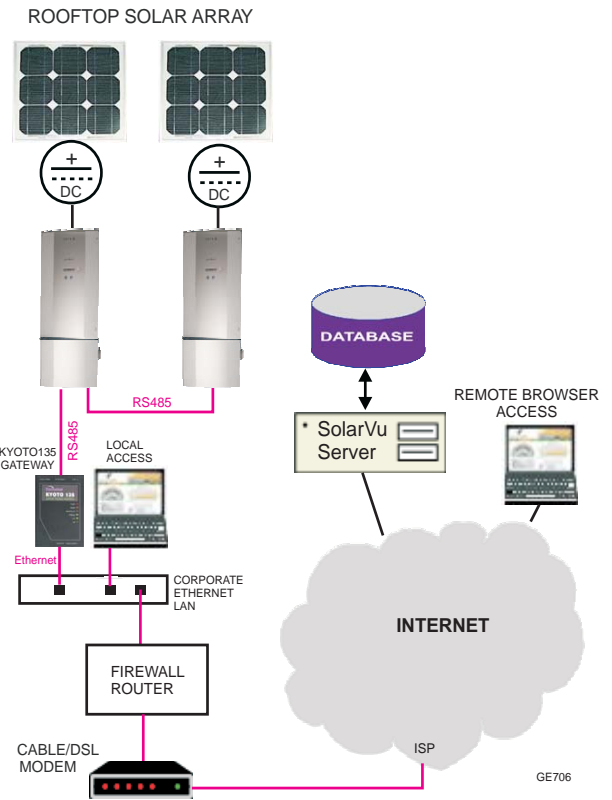
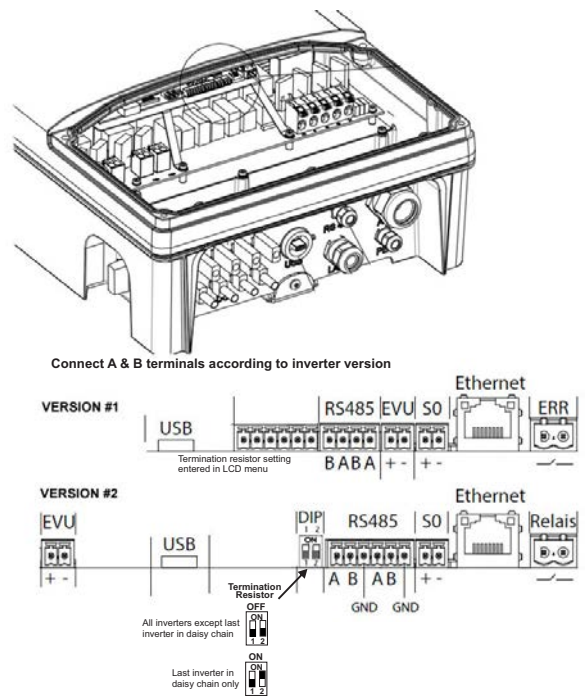
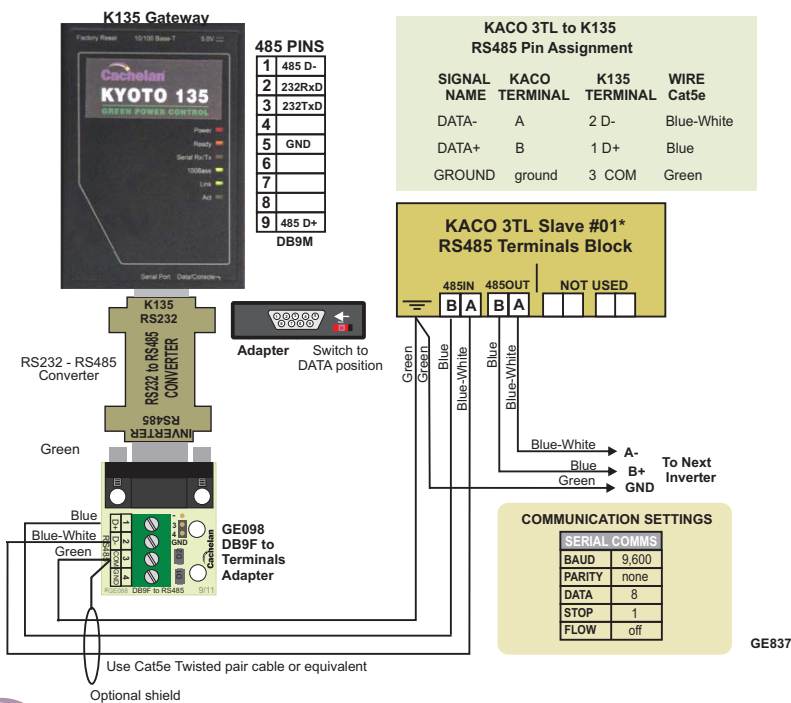

Fig 2 K135-KACO XP10U RS485 connections



Network Setup

On power up, the K135 looks for a DHCP server to provide it a dynamic IP address. If a PC connected to the network can automatically connect to the internet through a browser then the network is already configured to accept the K135. Otherwise consult the IT systems administrator for assistance. If a dedicated IP address, subnet mask and DNS server address are required, this needs to be entered into the K135 before shipment. Once the K135 receives its IP address it acts as a client. It will automatically try to connect to the SolarVu™ server and begin transferring data from the inverter to the server.

K135 indicators and connections



Testing

Ensure the inverters and K135 are powered on, the ethernet cable is plugged into a network jack and the RS485 cable is connected between the K135 and the inverter. The Power and Ready lights should be on if the power supply is plugged in. The Link light on indicates the ethernet connection is working. 100Base will only be on for high speed connections; for 10Base it is off. The Act light will periodically flash showing network activity. The Serial Rx/Tx flashes when the inverter is polled by the K135 but most of the time the light is off.

Internet Connection

Power on the K135 and allow at least 2 minutes for communication to be established. From any internet connected computer, open the browser and type in the site address assigned for your account. This will be found on the account label shipped with the K135 and on the front panel of the K135 after the URL.

Once the website is reached, the opening screen is the SITE view. Click ANALYZER > INVERTER STATUS. If there is a connection from the site, the Last Communication light will be green. The K135 gateway does not need to be connected to the inverter for this light to be green. If this indicator is red, it indicates no internet connection has been established. Check internet connections at the site by trying to browse the internet at the site with a PC connected to the network.

If the K135 gateway is successfully collecting data from the inverter, the Last Data Updated indicator will be green and inverter data will appear. If this indicator is red but the Last Communication indicator is green, check the serial connection to the inverter and that it is operating. When both lights are green the gages on the SITE screen will display live data and graphs will begin recording site energy output.

K135 Status Indicator Interpretation

INDICATOR STATUS			
LED	NORMAL	STATUS	
POWER	ON	OFF- no power	ON-power OK
READY	ON	OFF	No DHCP or static IP address. Check IP settings, ethernet connection
SERIAL	FLASHING	OFF	Check RS232 to inverter connection. Inverter may be off.
100Base	ON	ON- 100Base, OFF- 10Base or no ethernet connection	
Link	ON	OFF	No ethernet connection
Activity	FLASHING	FLASH - data traffic activity	

TROUBLESHOOTING CHECKLIST	
IP	Obtain IP by DHCP or set static IP. Network configured to recognize K135
Serial	RS232 serial cable connected between inverter and K135
Inverter	Inverter is powered on
Internet	Internet connection from ISP to LAN is operating normally
K135	K135 in data mode (red switch set to left viewed from top)
Support	Technical support: contactus@cachelan.com

K135 front panel label with web address and login

K135 GATEWAY

URL: mysite.solarvu.net
USER: myusername
PASSWORD: mypassword
IP: DHCP
MAC: 00-01-95-06-E8-33
ID: SS100 070300075 v1.4.1
TYPE: Xantrex GT

Check ANALYSER > INVERTER STATUS for communication
 Screen shots may vary by inverter type

LIVE - for valid data, green status light and time received

Video Tour

For an overview of available features, visit www.solarvu.net and play the What is SolarVu video. Each screen has a HELP button that explains how all the features work. An online help guide is available for printing under **SETUP > DOWNLOADS > PRINTED HELP**.

Visit www.solarvu.net for a features video



Help guide



Site Screen

For a summary of information about the site, click the **SITE** menu button. On the upper left, the current charging status of the solar panels, total power being generated now and in the last 30 days is displayed. Underneath, the carbon footprint of energy equivalents is displayed since startup. Links to other websites can be left as defaults or changed in **SETUP** to personal preferences. The local weather is preset. Email contactus@cachelan.com to have it changed. For viewing on a widescreen TV suitable for display in a public place, click the **WIDE PAGE** button. On the right is a slideshow for public viewing. Content can be personalized using uploaded graphics in **SETUP**.

Site Summary Screen

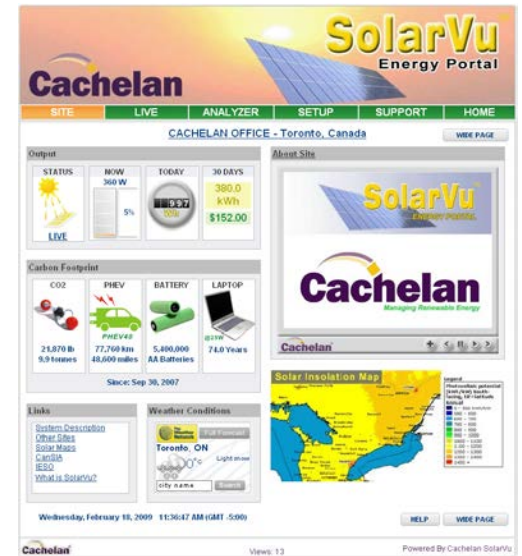

Select wide screen view for public display on an HDTV



LIVE view shows current conditions

Live Data

Click the **LIVE** menu button to display current power being generated in the array. Actual power and energy generated today are shown on the meter dial. For a normally operating system, the status indicator should be green with the last update time less than 15 minutes ago. Lifetime energy and revenue are shown digitally. For correct revenue display, the sell price per kWh must be entered in **SETUP**. If connection to the site is lost, or if an alarm is detected, the status indicator will be red. Click the Listen button with sound on for more information.

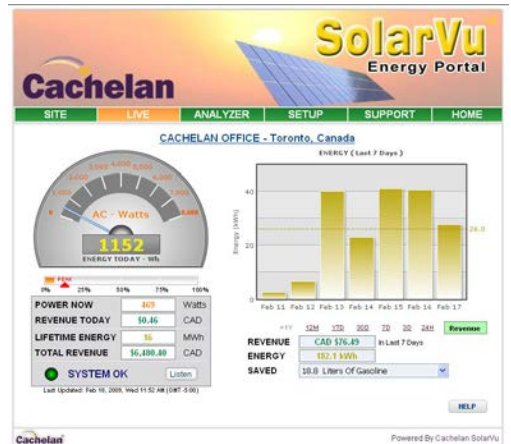

Trends are shown for the lifetime of the system using the graphs on the right. Select either an Energy or Revenue view using the button. Click the desired time period under the graph. Scroll over a data point with the mouse for more detailed information about that day. The carbon footprint pulldown gives energy equivalents for the solar power generated for the selected time period.

Analyzer - Performance

Click the **ANALYZER** menu button and select a category in the pulldown menu and a time period under the graph. The carbon footprint will compute the energy equivalents to the solar energy generated over the selected time period. This helps visitors get a practical feel for the benefits available. To find the carbon equivalent for an arbitrary value, override the actual solar amount by entering a kWh value and selecting a category, then click the Calculator button. Other views including buy/sell energy use, performance and payback can be selected with in the pulldown menu. The screen will return to the last value selected on return.

ANALYSER - select performance views from pulldown

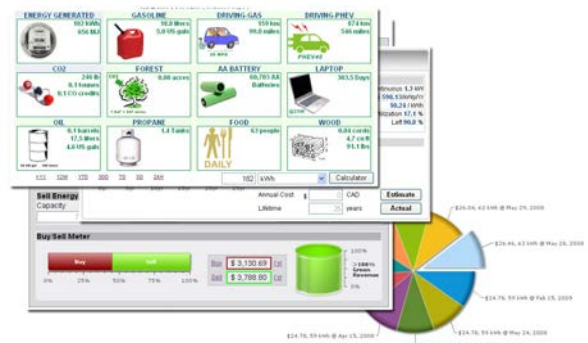

Analyzer - Troubleshooting

When problems occur with the system or to check inverter operation, click ANALYZER > INVERTER STATUS. Each inverter connected to the system with a K135 gateway will have its own display panel showing actual values sent. Remotely located technical personnel can assist in interpreting what the values are conveying. If no communication has been received from the device for more than 2 hours a No Data Available message will be shown.

For detailed analysis, it may be helpful to download all readings for the time period of interest into a spreadsheet for further analysis using SETUP > DOWNLOAD.



Download printable HELP guide or actual readings for any time period

Setup

For entering settings to configure your site, click the SETUP menu button. Enter your unique username and password from the account label. The setup screen appears showing communication status and current preference settings. Check the last communication time ❶. It should show a time within the last 15 minutes if communication between the site and SolarVu™ server is working normally.

For the payback and revenue calculators to work properly, correct parameters for energy sell rate, capacity, average insolation etc should be entered. Account > Equipment Setup is for factory use. All changes take immediate effect. The Site Setup tab is used to customize the banner, links, slideshow and system description. Click the Help ❷ button for each section for a description of the effect for each entry. For further analysis, individual energy readings for any time period can be downloaded into a spreadsheet from the DOWNLOAD section.

Enter the email address ❸ for each individual that wants a regular status report sent to them and select the frequency. This report will include energy and revenues for different time periods and indicate if there are any alarms. In the Password tab, include an email address to receive the Setup login password if this is forgotten.



Support

See the What is SolarVu? video at www.solarvu.net for a feature overview. Each screen has a HELP button with details for the items on that view. A printable HELP guide can be downloaded in SETUP > DOWNLOAD.

For additional technical support, send an email to contactus@cachelan.com or dial our support line in Toronto, Canada at 905.470.8400

Click ANALYZER > INVERTER STATUS for troubleshooting

Xantrex GT (North Array)						
DC INPUT	POWER	903.0 W	Volts	294.1 V	Amps	3.07 A
AC OUTPUT	POWER	793.0 W	Volts	212.4 V	Amps	3.90 A
PERFORMANCE	Efficiency	87.8 %	Frequency	60.0 Hz	Heat Sink	37 C
TODAY	Energy	7.132 Whr	Max Power	3.35 kW	Online	08h 20m
LIFETIME	Energy	8,151 kWh	Revenue	\$ 3,423.42	Run Time	607 Days
Inverter AC Watts					793	
Listen					Last Data Updated: Feb 26, 2009, Thu 3:42 PM (GMT -5:00)	
Listen					Last Communication: Feb 26, 2009, Thu 3:42 PM (GMT -5:00)	

Xantrex GT (South Array)						
DC INPUT	POWER	727.0 W	Volts	300.4 V	Amps	2.42 A
AC OUTPUT	POWER	640.0 W	Volts	211.8 V	Amps	3.13 A
PERFORMANCE	Efficiency	88.0 %	Frequency	60.0 Hz	Heat Sink	36 C
TODAY	Energy	5.609 Whr	Max Power	2.36 kW	Online	08h 18m
LIFETIME	Energy	8,175 kWh	Revenue	\$ 3,423.50	Run Time	607 Days
Inverter AC Watts					640	
Listen					Last Data Updated: Feb 26, 2009, Thu 3:42 PM (GMT -5:00)	
Listen					Last Communication: Feb 26, 2009, Thu 3:42 PM (GMT -5:00)	

See K135 label for SETUP login

Customer Login

Username
myusername

Password
mypassword

[Forgot your password?](#)

K135 GATEWAY
URL: mysite.solarvu.net
USER: myusername
PASSWORD: mypassword
IP: DHCP
MAC: 00-01-95-06-E8-33
ID: SS100 070300075 v1.4.1
TYPE: Outback Mate
DATE: Feb 2009
SUPPORT: cachelan.com

Configure site settings in SETUP

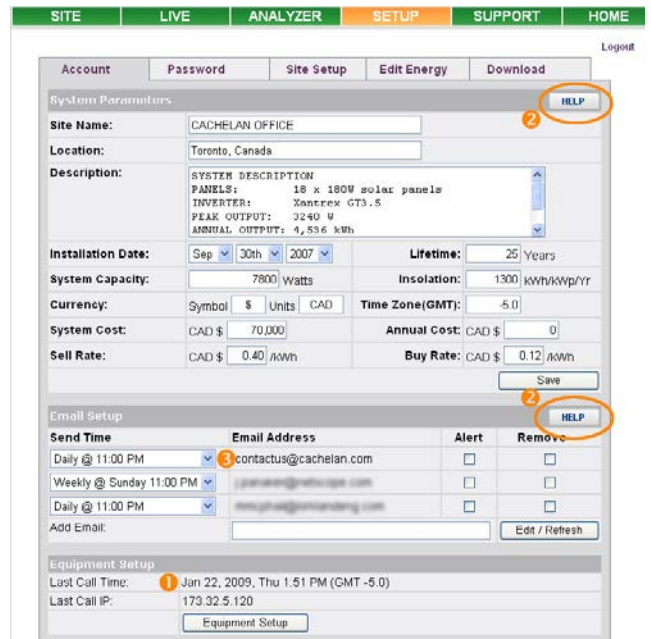

Cachelan Technical Support
contactus@cachelan.com
 905.470.8400 x228